



FLOWTRONIX (FT)



SAFETY DURABLES



SAFETY
DURABLES



Founded in 1990, **FLOWTRONIX (FT)** is a leading Manufacturer, Stockiest, Distributor and Supplier of the complete range of high quality Personal Protective Equipment (PPE) and safety solutions. We provide a diverse product portfolio for consolidated safety purchasing to our strategic end user clients, distribute products and services through our largest integrated network of resellers, retail stores and distribution centers.



Personal Protective Equipment (PPE)

FT offers a full range of safety solutions for your professional needs. We offer high quality personal protective equipments which guarantee protection against wide range of risks associated with high degree of comfort for our users. We supply our products to all industrial sectors that need protective equipment for their manpower against all kinds of occupational hazards. FT work towards by implementing a total "Head-to-Toe" safety concept to the HSE standards by providing authentic, environment friendly and quality Personal Protective Equipment.

FT SAFETY FIRST AT EVERY WORKPLACE

Serious injury or death in the workplace changes lives forever - for the families, friends, co-workers, employer and communities. That is why it is very important to apply Safety First philosophy in every workplace. Effective health and safety in your workplace can helping keeping your employees happy and productive, at the same time reduces the human and business costs of injuries.

SAFETY DURABLES



SAFETY DURABLES

Our cabinets, traffic cones and windsock are designed for durability and can withstand the test of time. Its construction will not corrode, colors will remain vibrant, and its high-performance fittings will not let you down. Our Safety Durables products have quality standards around long-term exposure conditions.

We can also advise you on the best cabinet, traffic cones, and windsock for your needs. Alternatively, we can manufacture bespoke products to your specification. Simply let us know the size, color and technical specification you require.



CONSENSUS STANDARDS, REQUIREMENTS, CODES AND LAWS

The placement of fire extinguishers and fire extinguisher cabinets is driven by a group of consensus standards, requirements, codes and laws. Ultimately, where, how many, and what type, will be determined by the authority having jurisdiction for that location. The authority could be as diverse as the City Building Inspector or the Deputy Chief of Staff for Installations and Logistics.

The requirements that establish placement practice are ultimately found in local fire prevention codes at one end of the spectrum or Federal Law at the other end.

FIRE EXTINGUISHER SIZE AND PLACEMENT CRITERIA (PER NFPA 10)

For Class A Hazards			
Criteria	Light Occupancy	Ordinary Occupancy	Extra Occupancy
Minimum Rated Single Extinguisher	2-A	2-A	4-A
Maximum Floor Area per Unit of A	3,000 sq. ft.	1,500 sq. ft.	1,000 sq. ft.
Maximum Floor Area for Extinguisher	11,250 sq. ft.	11,250 sq. ft.	11,350 sq. ft.
Maximum Travel Distance to Extinguisher	75 ft.	75 ft.	75 ft.

For Class B Hazards		
Type Of Hazard	Maximum Ext'g Rating	Maximum Travel Distance To Ext'g
Light (Low)	5-B 10-B	30 ft. 50 ft.
Ordinary (Moderate)	10-B 20-B	30 ft. 50 ft.
Extra (High)	40-B 80-B	30 ft. 50 ft.

FOR CLASS C HAZARDS

Class C ratings are required where energized electrical equipment is encountered. Since fire itself is a Class A or B hazard, the extinguishers are sized and located on the basis of the Class A or B hazard.

INSTALLATION OF FIRE EXTINGUISHERS

Portable fire extinguishers shall be securely installed on the hangers or in the bracket supplied or placed in cabinets or wall recesses. Wheeled-type extinguishers shall be in a designated location. Extinguishers having a gross weight not exceeding 40 Lbs. shall be installed so that the top of the extinguisher is not more than 5' above the floor. Extinguishers having a gross weight greater than 40 Lbs. shall be installed so that the top of the extinguisher is not more than 3'-6" above the floor.



SAFETY DURABLES



A fire can happen in an instant. It can charge through a building in no time injuring people, destroying assets, threatening the existence of your business.

These risks of accidents can be reduced through the help of fire safety cabinets. These are made to store fire extinguishers, hose and other fire equipments to make it accessible and available during accidents. It helps you organize, segregate and visually identify your fire safety equipments at all time.

Our selection of safety cabinets as well as traffic cones & windsock are compliant to the international standards and good choice for industrial, commercial & laboratory facility needs.

SAFETY DURABLES RANGE:

- Fire Extinguisher Cabinet 06
- Fire Hose Reel Cabinet 08
- Fire Fighting Equipment Cabinet..... 10
- Traffic Safety Cone 12
- Windsock 14



SAFETY DURABLES

SAFETY DURABLES

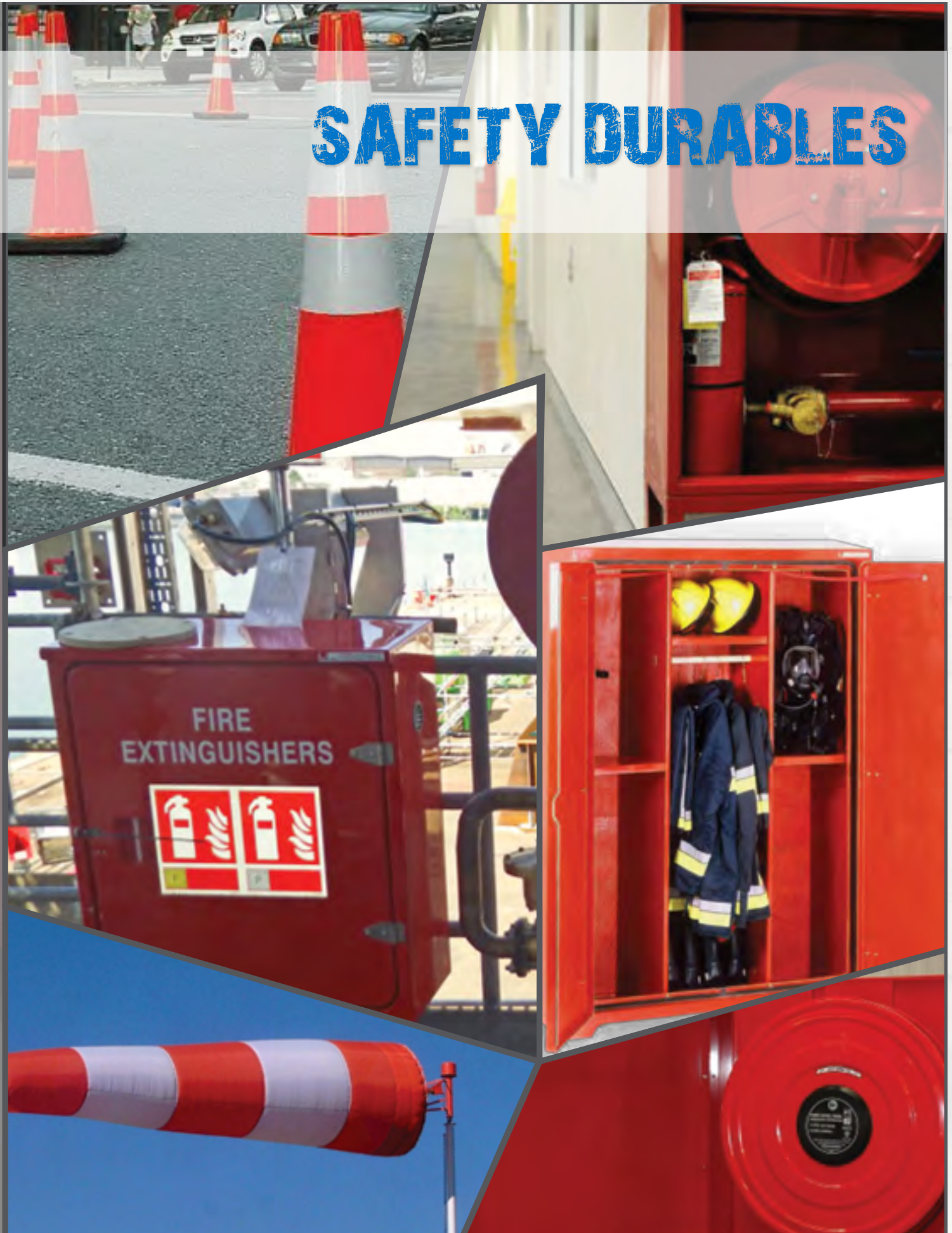



**SAFETY
DURABLES**

FIRE EXTINGUISHER CABINET

• Specifications & Features:

- The quality of workmanship and finishes are carefully planned and executed from the initial stage of preparing the material, fabrication, up to the surface preparation and powder coating.
- Feature durable, versatility, unitized construction for economical solution
- Designed for all types of buildings
- Fire extinguisher storage
- Material: 3-4 mm nominal thickness GRP
- Door catch: Nylon ball and socket catch
- Door handle: Recessed Nylon rod
- Hinges: Stainless steel
- Seal: EPDM seal (Ethylene Propylene Diene Monomer)
- Reinforcement: 100mm Square pads to back
- Optional: Cabinet dimensions and specification can be changed to meet your requirements



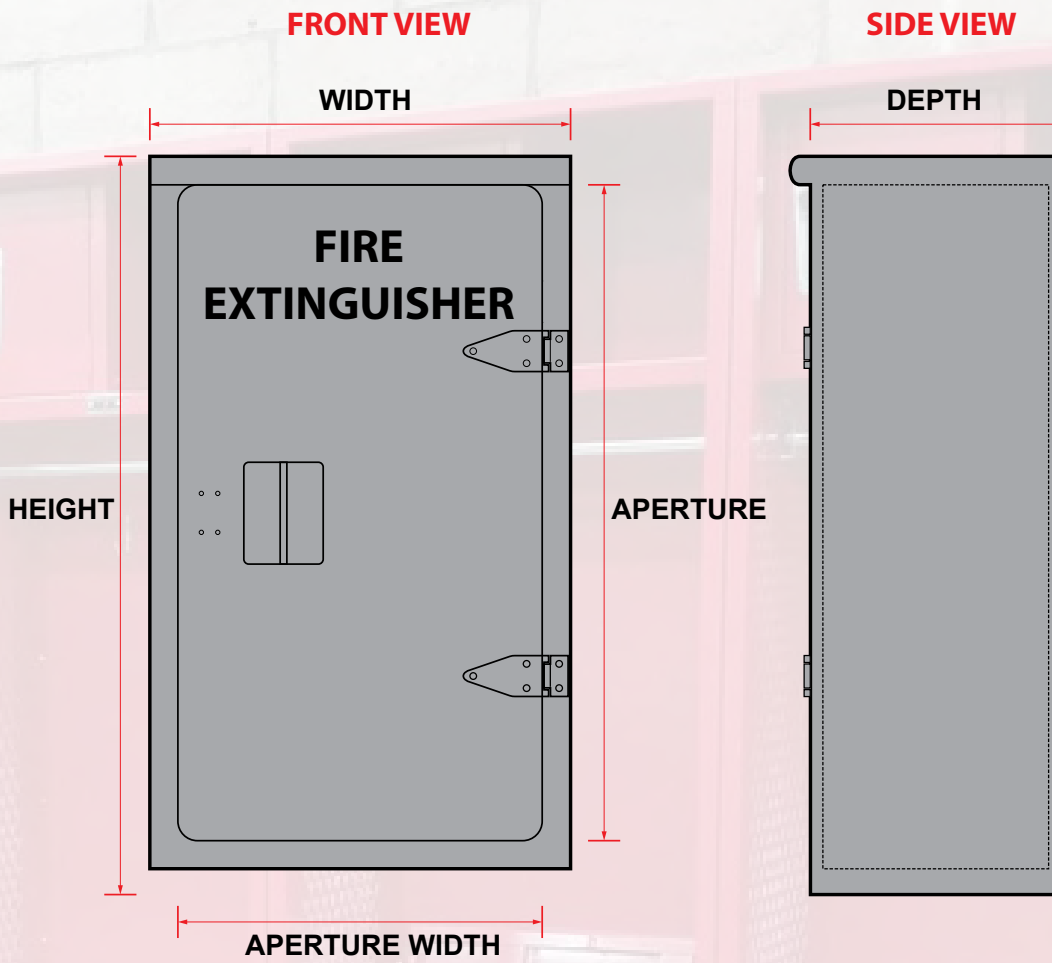

Colors

- RD
- BL
- GR
- OR
- YL
- WH
- GY

SAFETY DURABLES



Recessed Nylon Rod



Stainless Steel Hinge



EPDM seal



Nylon ball and socket catch

Dimensions / Size Chart			
Fire Ext. Storage Up to	Dimension (H x W x D)	Door Aperture (H x W)	Nominal Weight
1 x 9L / 9kg	800 x 373 x 277 mm	659 x 236 mm	10 (± .5) kg
1 x 12L / 12kg e	970 x 470 x 346 mm	800 x 305 mm	10 (± .5) kg
2 x 9L / 12kg	816 x 548 x 344 mm	650 x 391 mm	11 (± .5) kg
2 x 12L / 12kg	950 x 820 x 350 mm	750 x 633 mm	15 (± .5) kg
1 x 5kg CO ²	1080 x 438 x 335 mm	895 x 260 mm	11 (± .5) kg



FIRE HOSE REEL CABINET

• Specifications & Features:

- Have an attractive and compact design with universal high quality standards
- Designed to protect fire hose of all types, size, and lengths
- Quality of workmanship and finishes
- Fire hose storage and branch pipe
- Fitted with 2 x stainless steel hose pins
- 1 x Double nozzle bracket
- Material: 3-4 mm nominal thickness GRP
- Door catch: Nylon ball and socket catch
- Door handle: Recessed Nylon rod
- Hinges: 316 Stainless steel
- Seal: EPDM seal (Ethylene Propylene Diene Monomer)
- Reinforcement: 2 x 100mm Square pads to back
- Optional: Cabinet dimensions and specification can be changed to meet your requirements



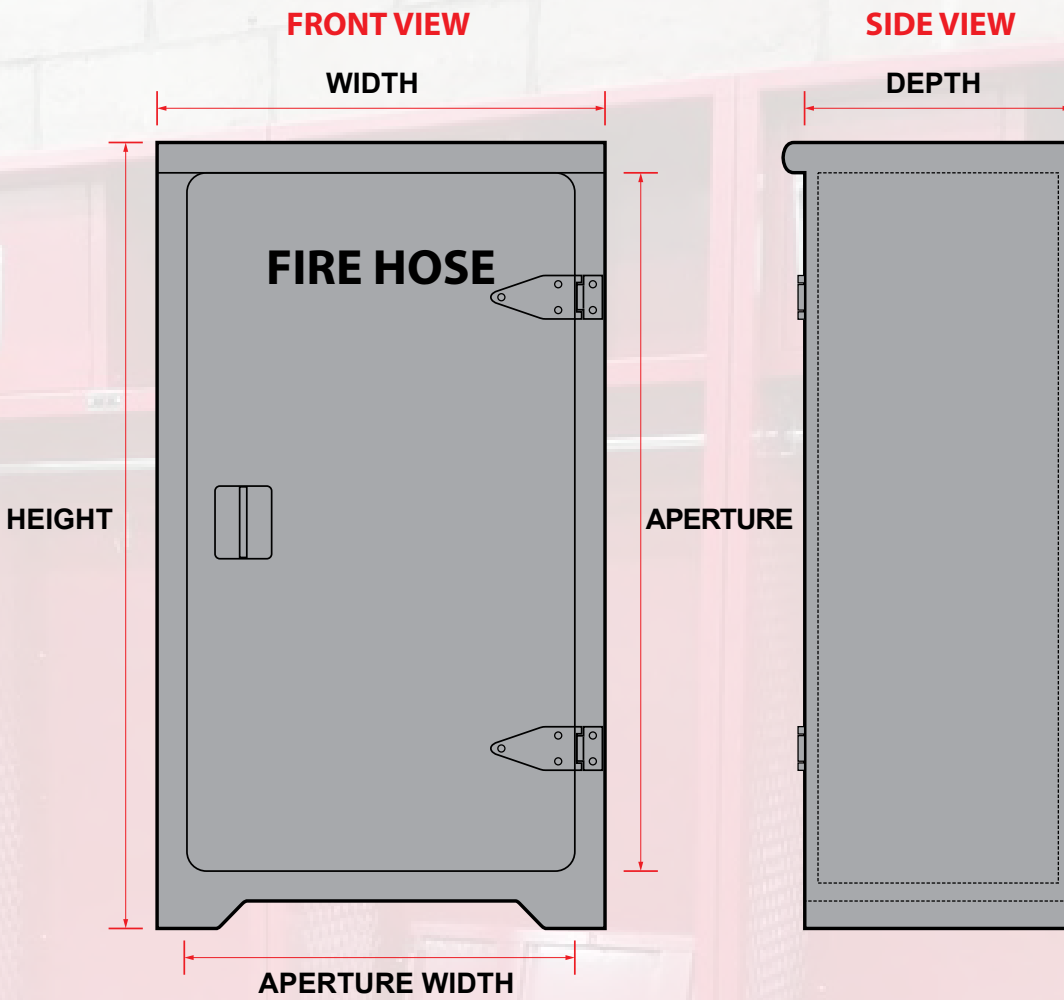

Colors

- RD
- BL
- GR
- OR
- YL
- WH
- GY

SAFETY DURABLES

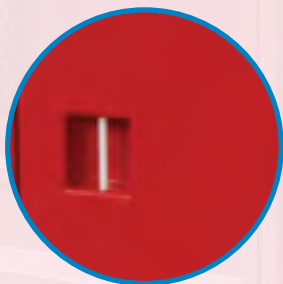

Recessed Nylon Rod



Stainless Steel Hinge



EPDM seal



Nylon ball and socket catch

Dimensions / Size Chart			
Fire Hose Storage Up to	Dimension (H x W x D)	Door Aperture (H x W)	Nominal Weight
1 x 18m	625 x 528 x 240 mm	463 x 330 mm	7 (± .5) kg
2 x 23m	761 x 684 x 330 mm	587 x 487 mm	11 (± .5) kg
2 x 30m	950 x 820 x 350 mm	750 x 633 mm	15 (± .5) kg
4 x 23m	1291 x 620 x 448 mm	1064 x 440 mm	24 (± .5) kg
4 x 30m	1302 x 785 x 489 mm	1084 x 585 mm	26 (± .5) kg



FIRE FIGHTING EQUIPMENT CABINET

● Specifications & Features:

- Engineered to your specification and excellent weather protection
- Have an attractive and compact design with universal high quality standards
- Storage of 2 firefighters clothing, CABA, and other equipments
- Fitted with clips, shelves & hangrail
- Material: 3-4 mm nominal thickness GRP
- Door catch: Stainless steel lever handle with 3-way locking bars
- Door handle: Stainless Steel L handle
- Hinges: 316 Stainless Steel T
- Seal: EPDM seal (Ethylene Propylene Diene Monomer)
- Reinforcement: 150mm² pads to top corners of back
- Optional: Cabinet dimensions and specification can be changed to meet your requirements



FRONT VIEW

SIDE VIEW

Colors

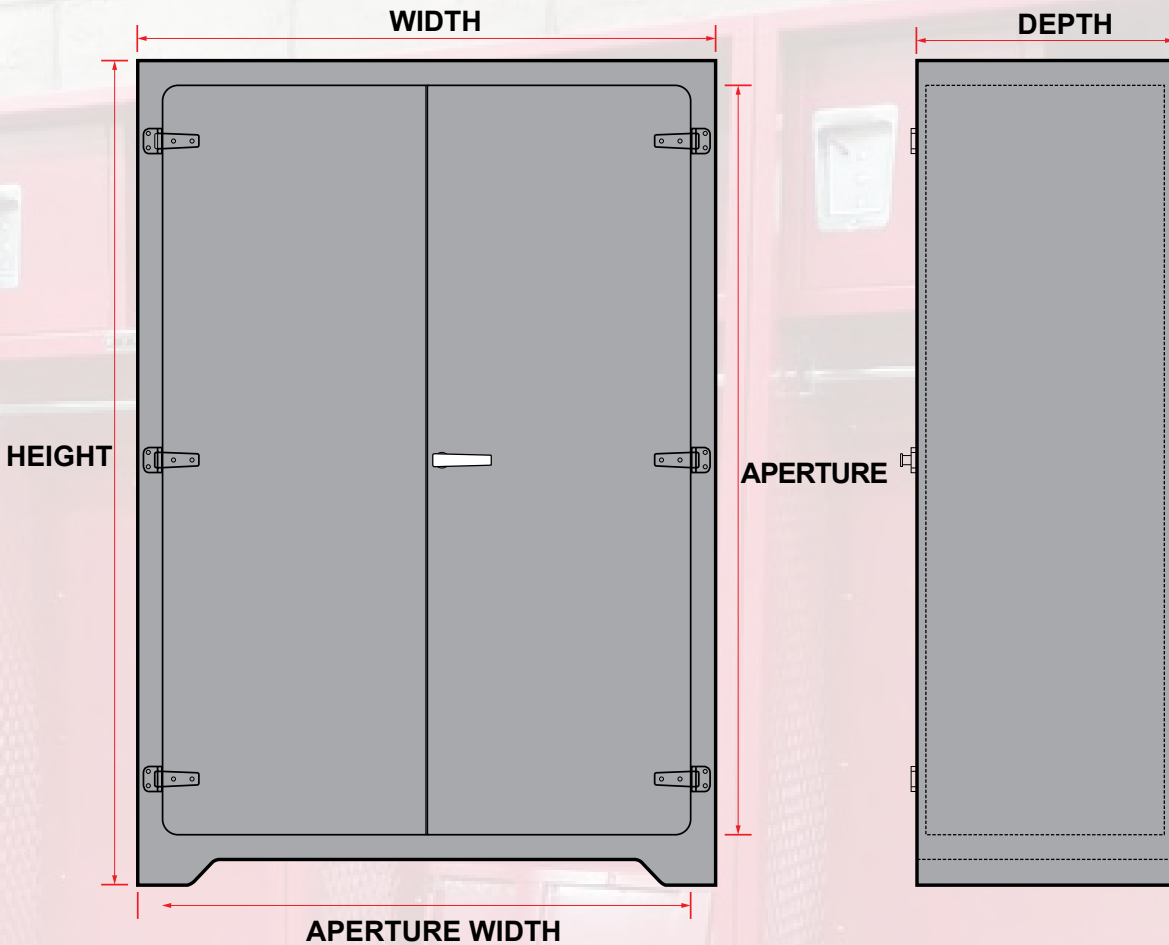

- RD
- BL
- GR
- OR
- YL
- WH
- GY



Stainless Steel L Handle



Stainless Steel Hinge



EPDM seal

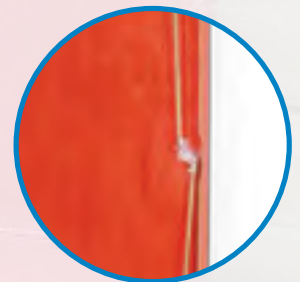

Lever handle with 3-way locking bars

SAFETY DURABLES

Dimensions / Size Chart

Breathing Apparatus (BA) Set + Fire Fighting Suit (FFS)	Dimension (H x W x D)	Door Aperture (H x W)	Nominal Weight
1 x BA set & FFS (folded)	1302 x 785 x 489 mm	1084 x 585 mm	22 (± .5) Kg
2 x BA set & FFS (folded)	1530 x 910 x 495 mm	1236 x 706 mm	33 (± .5) Kg
5 x FFS (hanged)	1831 x 1034 x 785 mm	1583 x 812 mm	50 (± .5) Kg
2 x BA set & FFS (hanged)	2015 x 1385 x 460 mm	1739 x 1164 mm	50 (± .5) Kg
4 x BA set & FFS (hanged)	2025 x 1395 x 600 mm	1739 x 1160 mm	60 (± .5) Kg



TRAFFIC SAFETY CONES

Specifications & Features:

- Maintenance free
- Pavement gripping bottoms ensure stay in place
- Cones conveniently stack for quick and easy storage and no sticking when removed
- Durable and reboundable
- With or without reflective collars
- Materials: Premium grade PVC constructions

A. Flow Molded with reflective tapes

B. Flow Molded without reflective tapes

C. Injected Molded Two-piece, Interlocking base with reflective tapes

D. Injected Molded Two-piece, Interlocking base without reflective tapes



Flow Molded with reflective tapes



Flow Molded without reflective tapes

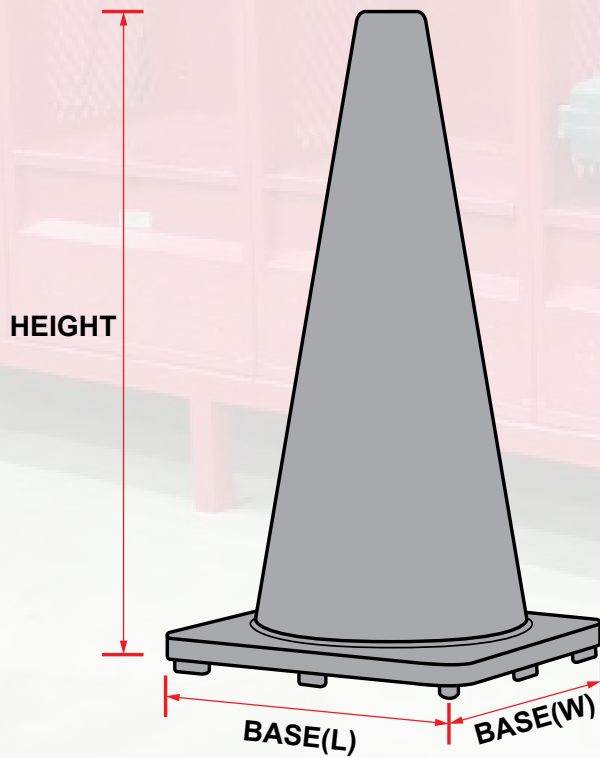



C

Injected Molded
Two-piece, interlocking
base with reflective tapes



D

Injected Molded
Two-piece, interlocking
base without reflective tapes

Optional: Traffic Safety
Cones reflective collars
and specification can be
changed to meet
your requirements

Colors

- RD
- BL
- GR
- OR
- YL
- WH
- PK
- LM
- BK
- PL

SAFETY DURABLES

Dimensions / Size Chart - Flow Molded Single Piece			
Height	Base Size (L x W)	Flow Molded Nominal Weight	Injected Molded Nominal Weight
12"	210 x 210 mm	0.8 (± .2) kg	1.2 (± .2) Kg
18"	280 x 280 mm	1 (± .2) kg	1.5 (± .2) Kg
28"	360 x 360 mm	2 (± .3) kg	3 (± .3) Kg
36"	360 x 360 mm	4 (± .3) kg	5 (± .3) Kg

Why Use A Safety Cone?

When other driver don't see a person or vehicle on the side of the road accidents happen.

1. Safety cone add an unusual visual element to the road-side scene which increases the probability that will pay attention and respond with caution as they approach.
2. Safety cones send a strong message to approaching drivers that there is a stationary hazard up ahead - a car with its flashers on could mean anything and may not even be stationary.
3. If your car has broken down due to an electrical problem, your flashers may not work at all.
4. If your vehicle is parked close to a blind corner, you can use your safety cones to give advance warning to approaching drivers and getting them to slow down before it is too late.

Any time you're stopped in an exposed area with any degree of risk from passing vehicles, you should deploy and activate one or more safety cones, particularly at night or in bad weather, but also at any time in any conditions.



WINDSOCKS

• Specifications & Features:

- Fabrics: Polyurethane coated Polyester
- Fabric weight: 115 gsm
- Grommets: 1/4" Brass grommets (Number of eyelet optional)
- Attached method:
 - a. At the mouth, sewn in to frame
 - b. Using cable tie, attach windsock to frame with the cable tie 'buckle in' inside grommets to the rim
- Windsock Applications:
 - Airports and private airstrips.
 - Chopper landing pads.
 - Air ambulance locations.
 - Parachute, Paragliding and Micro light Flying.
 - Model Aircraft Clubs
 - Safety in the oilfield, gas and petrochemical industry
 - Emergency Planning Equipment
 - Power Stations
 - General weather bureau
 - Road and highway cross wind indication
 - Water and sewage treatment works
 - Ports and marines



Plain Red windsock



Red and White striped windsock



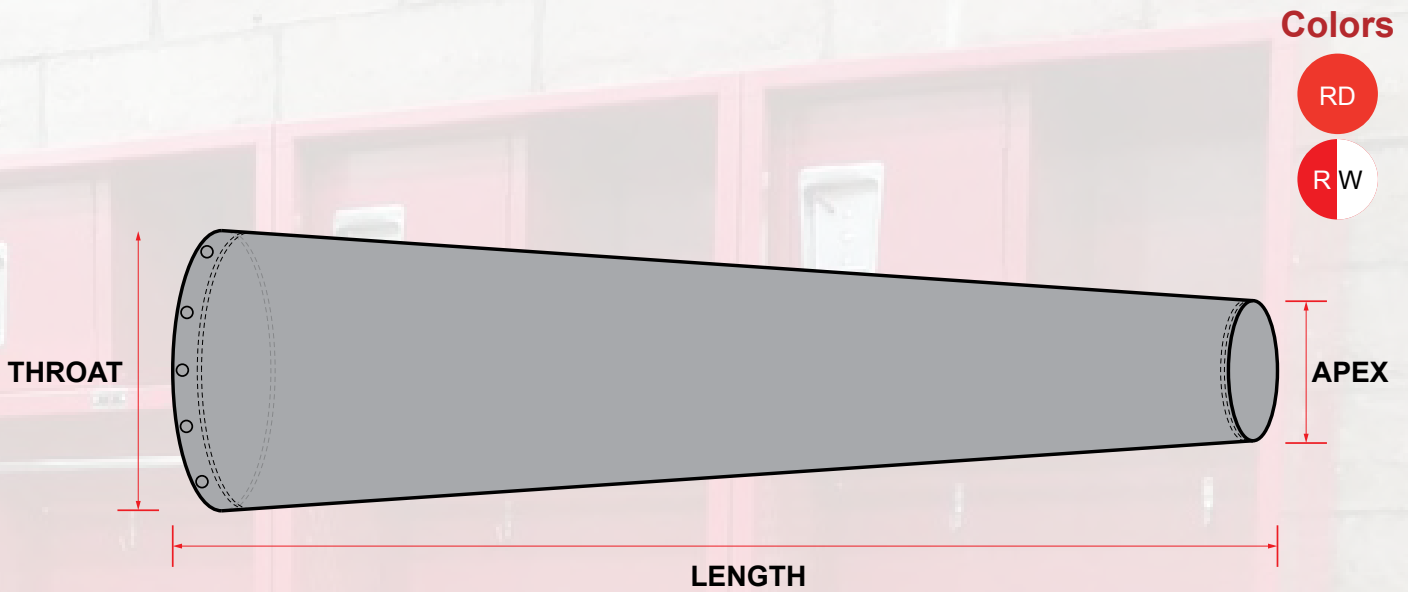

Optional: Windsocks specification can be changed to meet your requirements



Airports



Chopper landing pads



Safety in the oilfield, gas and petrochemical industry



Ports and marines

SAFETY DURABLES

Dimensions / Size Chart

Throat	Apex	Length
10" (25.4 cm)	5" (12.7 cm)	36" (3 Ft.)
18" (45.72 cm)	9" (22.86 cm)	60" (5 Ft.)
18" (45.72 cm)	9" (22.86 cm)	96" (8 Ft.)
24" (60.96 cm)	12" (30.48 cm)	60" (5 Ft.)
24" (60.96 cm)	12" (30.48 cm)	96" (8 Ft.)
24" (60.96 cm)	12" (30.48 cm)	144" (12 Ft.)

How Does a Windsock Determine the Direction of the Wind?

Windsock flows freely with the wind however, the direction the windsock flows in is not always the direction of the wind. The direction of the wind faces the opposite direction to the windsock.



FLOWTRONIX (FT) FZE.
P.O. Box: 17154,
Jebel Ali-JAFZA, Dubai, U.A.E
E-mail: ft.ja@flowtronix.com
Tel.: +971-4-8806650, Fax: +971-4-8806651
Web: www.flowtronix.com

